

# AMANO

## PIX-25

Atomic Time Clock

Operation Manual



## Proprietary Notice

This document contains proprietary information and such information may not be reproduced in whole or part without the written permission from Amano Cincinnati, Inc. 140 Harrison Ave., Roseland, New Jersey 07068.

Amano Cincinnati, Inc. reserves the right to make equipment changes and improvements, which may not be reflected in this document. Portions of this document may have been updated to include the latest hardware or firmware version, if applicable. We recommend that this document be read in its entirety before any attempt is made to operate the equipment.

## ***Thank You....***

For purchasing another fine product from  
Amano Cincinnati, Inc.

**Important!** Do not return this clock to the retailer. If you have any questions or need assistance, please call us toll free at 1-800-253-9836 8:15 am – 5pm EST  
e-mail: [customersupport@amano.com](mailto:customersupport@amano.com)

Find Answers to frequently asked questions, and general product information such as a more detailed owner's manual for this product at [www.amano.com/tkb](http://www.amano.com/tkb) and search for PIX-25

Need Ribbons, Keys and Accessories?  
Visit

[www.amano.com/time](http://www.amano.com/time)

Or call 1-800-253-9836

Ribbon # CE-315151

Key # AJR-201150

**Note:** This equipment has been tested and found to comply with the limits for a Class A digital device, pursuant to part 15 of the FCC Rules. These limits are designed to provide reasonable protection against harmful interference when the equipment is operated in a commercial environment. This equipment generates uses and can radiate radio frequency energy and, if not installed and used in accordance with the instruction manual, may cause harmful interference to radio communications. Operation of this equipment in a residential area is likely to cause harmful interference in which case the user will be required to correct the interference at his own expense.

### External View

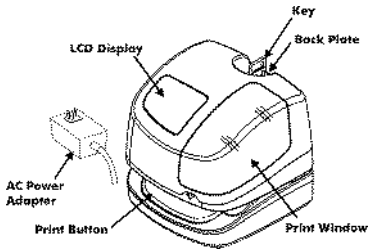

### Internal View

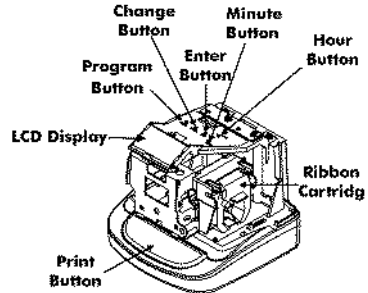

- The **PROGRAM** button is used to enter and exit the Program Mode.
- The **CHANGE** button is used to change the information on the display.
- The **ENTER** button is used to accept the information shown on the display and save it in memory.
- The **HOUR** button advances the hour in the display by increments of 1.
- The **MINUTE** button advances the minutes in the display by increments of 1.

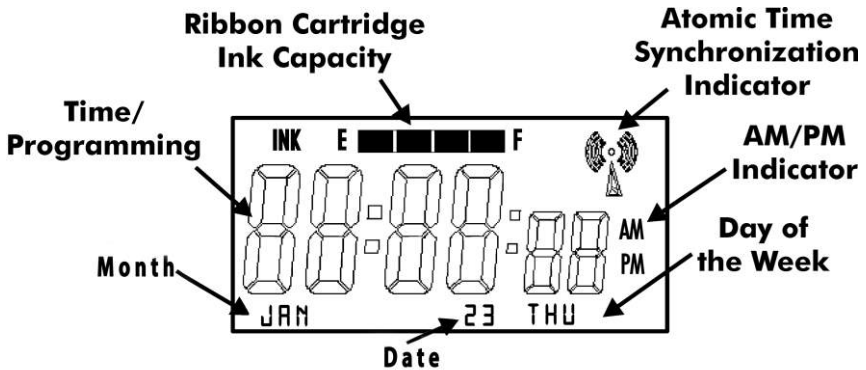

The LCD Display contains an Ink Capacity gauge. This gauge indicates the amount of ink remaining in the ribbon cartridge using four bar segments, from E (Empty) to F (Full).

The PIX-25 calculates the ink capacity of the ribbon cartridge from the number of imprints made. As the ink capacity decreases, the bars in the gauge will disappear.

## Removing the Cover and Packing Material

1. Plug the clock in (power up).
2. Insert the key provided and make a quarter turn clockwise to unlock the cover.
3. Lift the cover to remove.
4. Remove the cardboard spacer located above the ribbon cartridge by pulling straight out.
5. Remove the spacer between the Ribbon Cartridge and the Printer Carriage.

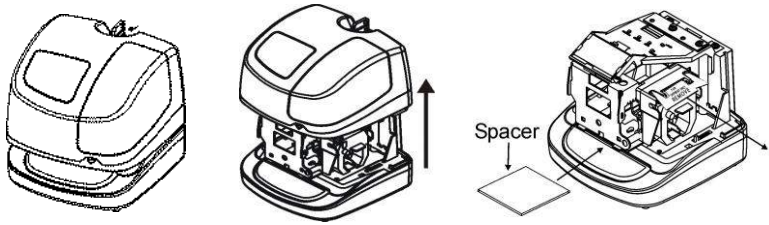

## Making a Test Print



**Note: Your clock is preset with the correct year, month and date. The hour may need to be set to your location.**

1. Make sure the PIX-25 is plugged in.
2. Insert a piece of paper or time card into the PIX-25. The clock will automatically print YEAR, MONTH, DATE and TIME with AM or PM.

'15MAY 9 10:00AM

3. If the imprint is satisfactory, the PIX-25 is ready for use.

## Setting the Time (If Displayed Time is Incorrect)

1. Unlock and remove the cover.
2. Press the **HOUR** button until the correct hour appears.
3. Press the **MINUTE** button until the correct minute appears.

## Setting the Year, Month and Date (If Incorrect)

1. Press and hold the **PROGRAM** button until **P1 {TIME}** appears, then press the **CHANGE** button to select **P2 {DATE}**, then press the **ENTER** button.
2. Press the **CHANGE** button to select correct **YEAR**, then press the **ENTER** button.
3. Press the **CHANGE** button to select correct **MONTH**, then press the **ENTER** button.
4. Press the **CHANGE** button to select correct **DATE**, then press the **ENTER** button twice.
5. Press the **PROGRAM** button to exit

## Changing the Print Style

1. Press and hold the **PROGRAM** button until **P1 { TIME }** appears
2. Press the **CHANGE** button until **P4 { PRT STYLE }** appears, then press the **ENTER** button.
3. The display will flash the current setting. Press the **CHANGE** button until the desired print style code appears (see diagram).
4. When the display flashes the correct setting, press the **ENTER** button and press the **PROGRAM** button to exit.

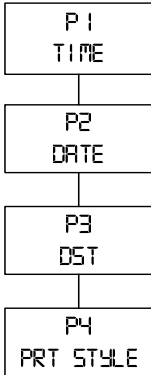

|       |  |                    |
|-------|--|--------------------|
| PR-1  | 2 digit year, month, date 12hr, 60 <sup>th</sup> /hr     | '15JAN27 2:25PM    |
| PR-2  | 2 digit year, month, date 24hr, 60 <sup>th</sup> /hr     | '15JAN27 14:25     |
| PR-3  | 2 digit year, month, date 24hr, 100 <sup>th</sup> /hr    | '15JAN27 14.42     |
| PR-4  | 2 digit year, month, date 24hr, 10 <sup>th</sup> /hr     | '15JAN27 14.4      |
| PR-5  | 2 digit year, month, date 24hr, 60 <sup>th</sup> /hr,Sec | '15JAN27 14:25 36s |
| PR-6  | 4 digit year, month, date 12hr, 60 <sup>th</sup> /hr     | '2015JAN27 2:25PM  |
| PR-7  | 4 digit year, month, date 24hr, 60 <sup>th</sup> /hr     | '2015JAN27 14:25   |
| PR-8  | 4 digit year, month, date 24hr, 100 <sup>th</sup> /hr    | '2015JAN27 14.42   |
| PR-9  | 2 digit year, month, date 6 digit counter                | '15JAN27 012345    |
| PR-10 | month, date 24hr, 60 <sup>th</sup> /hr 6 digit counter   | JAN27 14:25 012345 |

## Changing the Print Direction

1. Press and hold the **PROGRAM** button until **P1 { TIME }** appears.
2. Press the **CHANGE** button until **P5 { OTHER }** appears. Press the **ENTER** button.
3. Press the **CHANGE** button until **P-52** flashes in the display. Press the **ENTER** button.
4. Press the **CHANGE** button until the correct print direction **RIGHT** (Right Side) or **LEFT** (Left Side) flashes in the display, then press the **ENTER** button.
5. Press the **PROGRAM** button to exit.

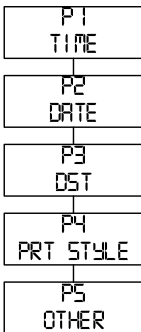

|      |           |
|------|-----------|
| P-51 | LANGUAGE  |
| P-52 | PRINT DIR |
| P-53 | PAPER DET |
| P-54 | LEAD ZERO |
| P-55 | NUMBERING |
| P-56 | DST BEGIN |
| P-57 | DST END   |
| P-58 | DISP HOUR |

## Disabling or Enabling Daylight Saving Time

Note: Your clock is preset (Enabled) at the factory to change automatically for daylight savings. To disable daylight savings follow the steps below:

1. Press and hold the **PROGRAM** button until **P1 (TIME)** appears then press the **CHANGE** button until **P3 (DST)** appears.
2. Press the **ENTER** button.
3. Press the **CHANGE** button to alternate between **ON** and **OFF**.
4. When the display flashes the correct setting, press the **ENTER** button.
5. The display will show **P3 (DST)**, press the **PROGRAM** button to exit the Program Mode.

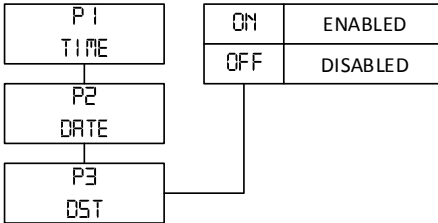

## Changing the Begin / End Date for DST

Note that the government standard for DST is subject to change. Your clock is factory-set for correct DST based upon when it was manufactured, but any revision to DST begin or end dates may require updating the system-set DST calendar.

The steps below change the begin and end date for DST. Updating the begin date for DST needs to be done just one time, since the clock's rolling calendar function will auto-calculate the begin date for each year thereafter. To change the *end* date for DST, refer to the next section.

1. Press and hold the **PROGRAM** button until **P1 (TIME)** appears, then press the **CHANGE** button until **P5 (OTHER)** appears and then press the **ENTER** button.
2. Press the **CHANGE** button until **P-56 (DST BEGIN)** flashes in the display.
3. Press the **ENTER** button and the year will start to flash. Press **CHANGE** button until correct year is displayed and then press **ENTER**.
4. The month will start to flash. Press **CHANGE** button until correct month is displayed and then press **ENTER**.
5. The date will start to flash. Press the **CHANGE** button until correct date is displayed and then press **ENTER** button twice to accept changes.
6. Press the **CHANGE** button until **P-57 (DST END)** flashes in the display.
7. Press the **ENTER** button and the year will start to flash. Press **CHANGE** button until correct year is displayed and then press **ENTER**.
8. The month will start to flash. Press the **CHANGE** button until correct month is displayed and then press **ENTER**.

- The date will start to flash. Press the **CHANGE** button until correct date is displayed and then press the **ENTER** button twice to accept changes.
- Press the **PROGRAM** button to exit the Program Mode.

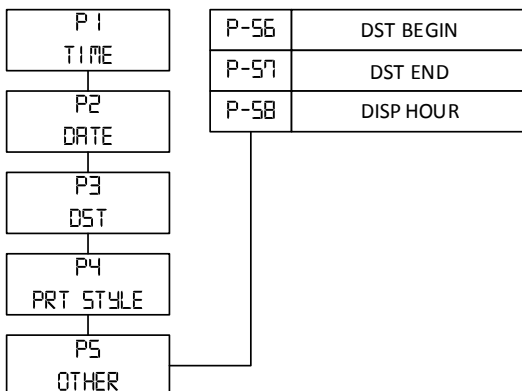

## Enabling or Disabling Auto Print

- Press and hold the **PROGRAM** button until P1 [TIME] appears, then the **CHANGE** button until P5 OTHER appears and then press the **ENTER** button.
- Press the **CHANGE** button until P-53 [PAPER DET] flashes in the display.
- Press the **ENTER** and the word [AUTO] will start to flash. Press the **CHANGE** button to change to MANUAL and then **ENTER**.
- Press the **PROGRAM** button to exit the Program Mode

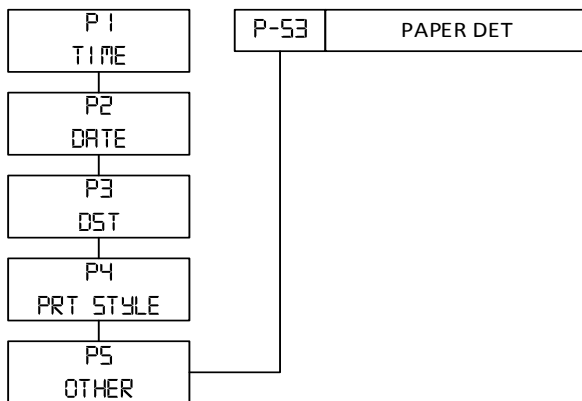

## Wall Mounting

Placement considerations:

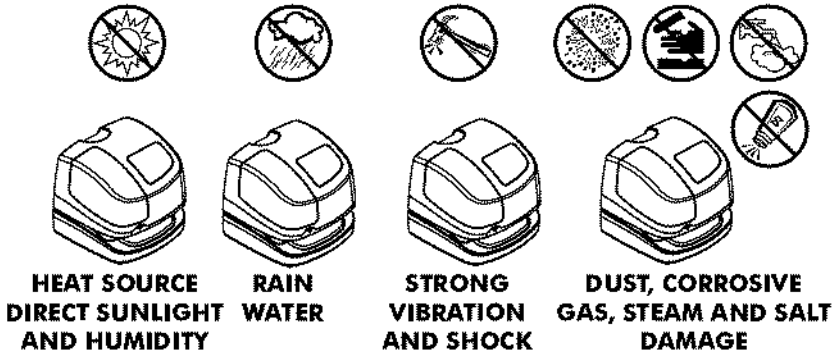

1. Insert the key provided and make a quarter turn clockwise to unlock the cover.
2. Remove the Cover and then remove the Back Plate by pressing the tab on the bottom of the clock as shown in the right-hand figure.

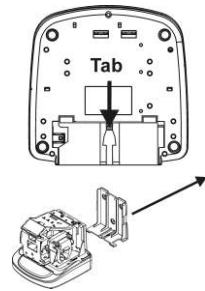
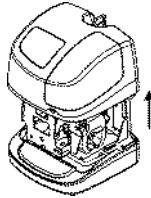

3. Using the Back Plate as a template, mark the lower mounting hole on the wall.
4. Mount the plate using a #10 wood screw (or equivalent) in the center mounting hole.
5. Level the Back Plate and mark the location of the two upper mounting holes. Secure to the wall using #10 wood screws (or equivalent).
6. Feed the AC Power Adapter cable through one of the holes in the Back Plate.

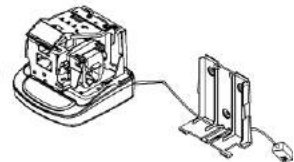
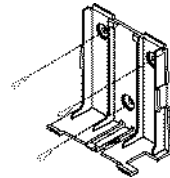



7. Align the clock with the two upper tabs on the back plate. Tilt the back of the clock upwards to fully insert the back plate tabs into the clock. Be careful not to pinch the power cord with the bracket.
8. Once the tabs are inserted, tilt the clock back down and push it against the wall. The tabs will snap into place.
9. Remove key and snap the cover back in place.

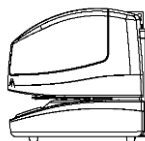
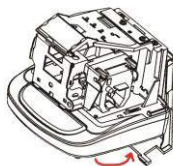
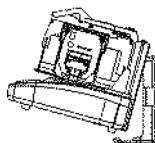

## Atomic Clock Feature

**NOTE: Only minutes and seconds are updated by the atomic clock. The hour must be set according to the time zone the clock is in.**

The Amano atomic clock receives time signals on long wave radio (60 kHz) from the National Institute of Standards and Technology (NIST) radio station WWVB, located in Fort Collins, Colorado, which is coupled with the atomic cesium clock in Boulder. The PIX-25 receives the WWVB time signal via its built-in antenna system. Your clock will try to find the signal on a daily basis.

The Atomic Time Synchronization Indicator in the LCD Display indicates the status of the signal. When you first receive the clock, it may be necessary to adjust the hour and minute. If your PIX-25 is located in an area that cannot receive the Atomic time signal, DO NOT be concerned, since the PIX-25 is able to accurately keep the time using its quartz mechanism (plus or minus three seconds per week).

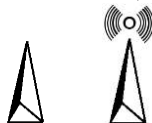

Searching  
for signal

Found  
signal

For more information about how radio-controlled clocks work, please visit:

<http://www.nist.gov/pml/div688/grp40/radioclocks.cfm>

## Disabling or Enabling the Atomic Clock

By default, the Atomic Clock function is enabled. If you wish to disable the atomic clock synchronization, or if you wish to re-enable synchronization, please do the following:

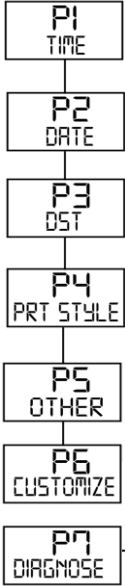

1. Press and hold the **PROGRAM** button until **P1 [TIME]** appears.
2. Press the **CHANGE** button until **P7 [DIAGNOSE]** appears.
3. Press the **ENTER** button.
4. Press the **CHANGE** button until **d4 [CLEAR]** flashes in the display. Press the **ENTER** button.
5. Press the **ENTER** button to move to the second digit and press the **CHANGE** button until the last digit of the code is the number **3** (to disable atomic clock) or the number **4** (to enable atomic clock).
6. Press **ENTER** to accept. The display will flash and code **[03]** or **[04]** will show on the display, press **ENTER** to accept. The display will show **d4 [CLEAR]**.
7. Press the **PROGRAM** button to exit.

|    |       |                          |
|----|-------|--------------------------|
| d4 | CLEAR | 03: Disable Atomic clock |
|    |       | 04: Enable Atomic Clock  |

## Ribbon Cartridge Replacement

1. Remove the cover.
2. Pull the two ribbon release tabs upward.
3. While holding the release tabs in an upward position, pull the ribbon cassette out of the cradle.
4. If the print mechanism is down and a piece of paper cannot be inserted, unplug the clock, then plug it back in to move the carriage up. This will make the ribbon installation easier.
5. Insert a new ribbon underneath the printer head as shown.
6. Turn the knob on the cassette clockwise one turn to take up any slack in the ribbon.
7. Check the printing quality to confirm that you have installed the ribbon properly.
8. Reset the INK capacity gauge by pressing the **CHANGE** and **ENTER** buttons at the same time
9. Replace the cover.

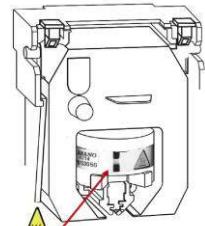
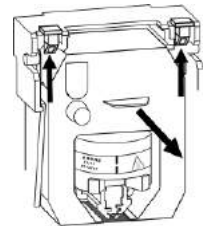

Caution! Print head may be hot

## Error Messages

| Error Code | Cause                             |
|------------|-----------------------------------|
| E 1        | Home sensor, motor carriage stuck |
| E 2        | Timing sensor, carriage stuck     |
| E 3        | Home sensor                       |
| E 4        | Carriage stuck                    |
| E 5        | General print error               |
| E 6        | Daylight Saving Time Program      |

For error messages E 1 through E 5 unplug the clock before checking to see that the carriage is not stuck or jammed. Also, check to see that the ribbon cables are in good condition. After clearing any jams, unplug the clock, then plug it back in. Contact us at 1-800-253-9836 if you need assistance.

The E 6 error message signifies that an attempt was made to get into the Program mode during the Daylight saving changeover one-hour lockout. Wait one hour and you will be able to program the clock.

## Cleaning

Do not use any chemical solvents or oils to clean or lubricate your PIX-25. This will damage your clock.

To clean the inside of your clock, blow it out with air.

## Resetting Clock After Extended Loss of Power

If there has been a power interruption of duration sufficient to drain the internal lithium battery, the date setting, the clock setting and the Daylight Saving Time setting will each need to be reset.

## Specifications

### Power Requirements

- **For Clock Input:** 15 VDC, 1.2A (Max.)
- **For AC Adapter:** 100 -240 VAC, 50/60Hz
- **Battery:** Lithium Battery for Memory Backup in case of power failure. (Factory installed). Shelf life of 3 years.

**Ambient Temperature:** -10°C to 45°C (14°F to 113°F)

**Ambient Humidity:** 10% to 90% (non-condensing)

**Dimensions:** 155mm Height (6.10 in), 175mm Depth (6.9 in).

**Weight:** Approximately 1.77kg (3.9 lbs.)

**Environment:** Indoor use only; dust-free environment. Keep out of direct sunlight.

### Standards Compliance:



## Warranty Information

**Limited Warranty Statement:** Amano Cincinnati, Inc. warrants this equipment to be free from defects in materials and workmanship for a period of one year from the date of purchase from an authorized distributor. If the equipment fails within the one year period, Amano Cincinnati, Inc. will, at its sole option, replace or repair at no charge, the equipment which, in its sole discretion is determined to be defective.

**There are no other warranties expressed or implied and Amano Cincinnati, Inc. disclaims any and all other warranties including, without limitations, implied warranties of merchantability and fitness or a particular purpose. Under no circumstances will Amano Cincinnati, Inc. be liable for consequential, incidental or similar damages, including lost savings, profits or other damages caused by use in connection with the product or the ability to use the product, even if the distributor or Amano Cincinnati, Inc. has been advised of such potential liability or other claims, repair or replacement constitutes your sole and exclusive remedy. Some states do not allow the limitation or exclusion of liability for incidental or consequential damages, so the above limitation or exclusion may not apply to you.**

During the one year period of warranty, Amano Cincinnati, Inc., will, at its sole option, replace or repair the returned product at no charge if it is determined by Amano Cincinnati, Inc. that the product has failed due to defects in materials and workmanship. If the failure is for any other reason, Amano Cincinnati, Inc. shall repair or replace the returned product and will charge a fee to cover repair or replacement, handling and service based upon its current price schedule in effect at the time of repair or replacement. Amano Cincinnati, Inc. reserves the right, at its sole option, to replace the returned product with a current product having similar features and functionality as determined by Amano Cincinnati, Inc. You, the customer are responsible for properly packing the product for shipment and for the charges for shipment and insuring the product during shipment to Amano Cincinnati, Inc. Amano Cincinnati, Inc. is responsible for the charges of shipment the repaired or replaced product back to you if it is determined that the product failed due to defects in materials or workmanship. If it is determined that the failure of the product was for reason other than defects in materials or workmanship, the product will be return to you C.O.D. for all charges. If the returned product has been modified without Amano Cincinnati, Inc. written consent or if the failure is the result of misuse, abuse, or misapplication, Amano Cincinnati, Inc. has no obligation to repair or replace the defective product. To obtain warranty service, this registration card must be returned to Amano Cincinnati, Inc. with proof of purchase in the form of an invoice from an authorized Amano Cincinnati distributor. For warranty and non-warranty service, contact the seller from whom you directly purchased the product.

For further instructions, extended warranty, or for the authorized Amano Cincinnati, service, support or parts distributor near you, call (800) 253-9836 or visit [www.amano.com](http://www.amano.com)

Any replacement or parts become the property of Amano Cincinnati, Inc.

## PRODUCT REGISTRATION

### ***Protect Your Investment***

Register your product for:

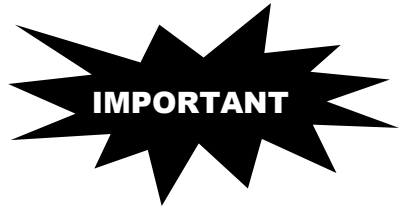

**Product Notifications**

We contact our customers in case of product updates, special offers and promotions.

**Owner Verification**

Registration can serve as verification of your ownership in the event of product theft or loss.

**Efficient Service**

Will help you obtain more efficient warranty service in case there is a problem with your product.

### ***Don't forget***

Please take the time to register your product. Registration takes 2 minutes.

**COMPLETE YOUR PRODUCT REGISTRATION ONLINE AT:**

<http://www.amano.com/registerclock>



# **AMANO**

*Corporate Headquarters*  
140 Harrison Avenue, Roseland, NJ 07068-1239  
(800) 253 -9836

***[www.amano.com/time](http://www.amano.com/time)***